







CAPACITY: *LOAD EVENLY DISTRIBUTED



CARE INSTRUCTIONS: We recommend to wipe over with a dry micro-fibre cloth to remove any dust. Avoid using a damp or wet cloth and any cleaning chemicals as this may cause damage to the surface.

PARTS LIST

<p>A</p>  <p>x3pcs</p>	<p>B</p>  <p>x3pcs</p>	<p>C</p>  <p>x4pcs</p>	<p>D</p>  <p>x6pcs</p>	<p>E</p>  <p>x6pcs</p>	<p>F</p>  <p>x3pcs</p>	<p>G</p>  <p>x3pcs</p>
---	---	---	---	--	---	---

ELEMENTS

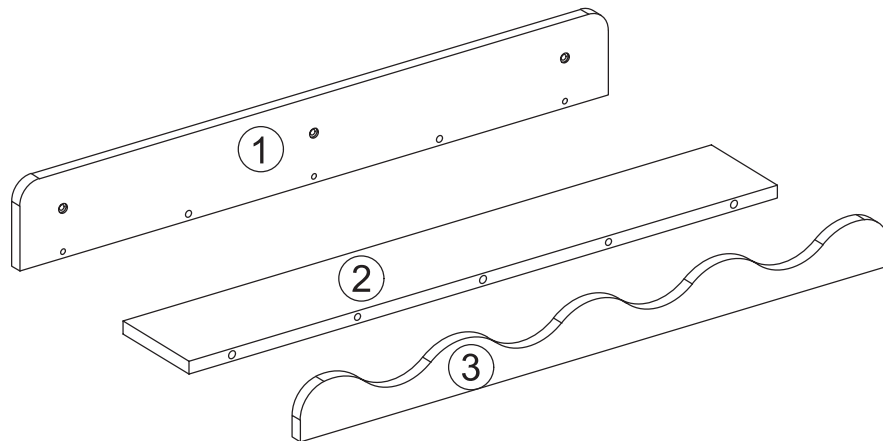

OPTION 1

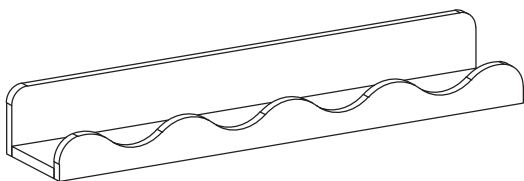

OPTION 2

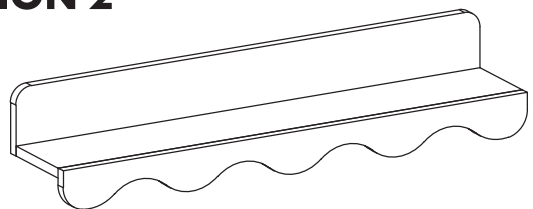

OPTION 3

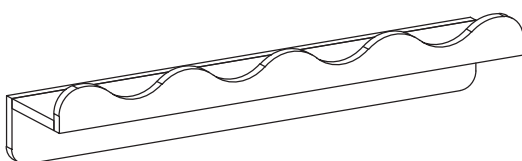

OPTION 4

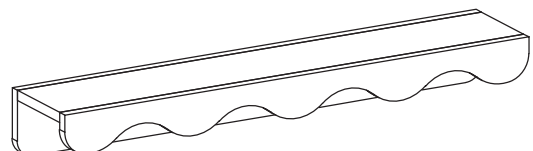

OPTION 1

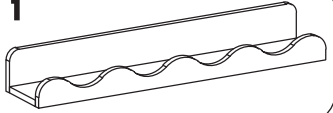

STEP 1

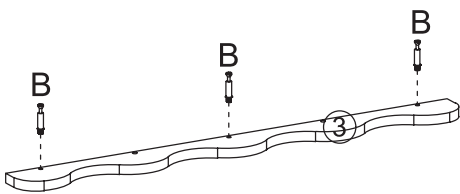

STEP 2

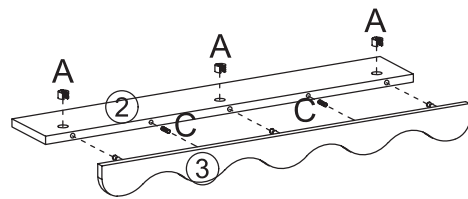

STEP 3

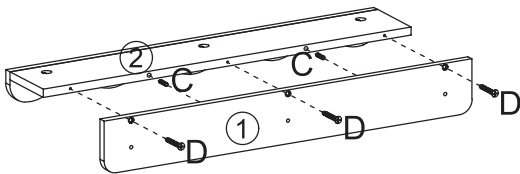

STEP 4

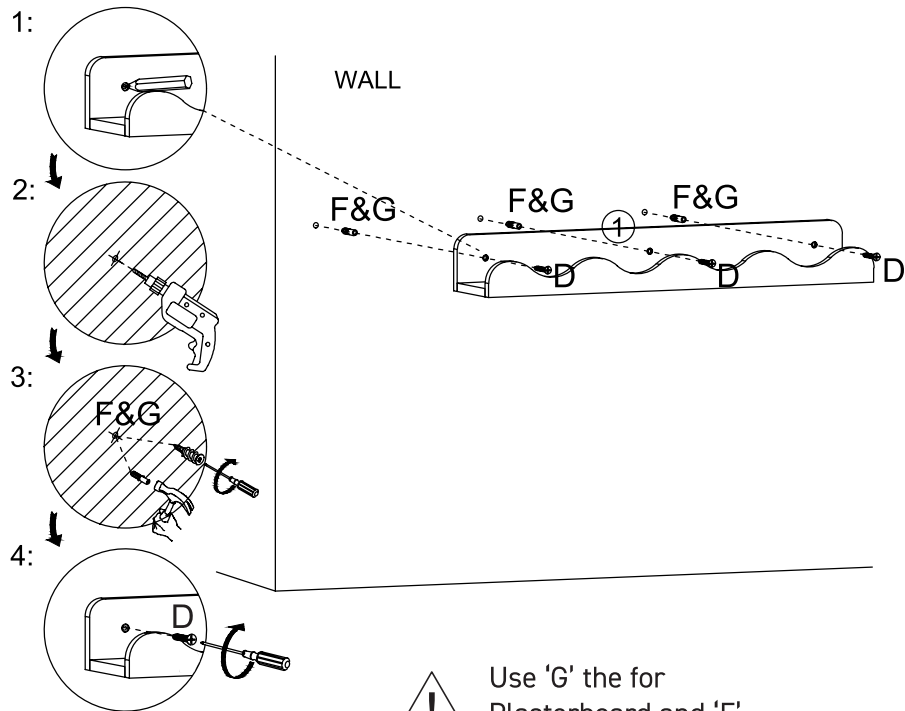

STEP 5

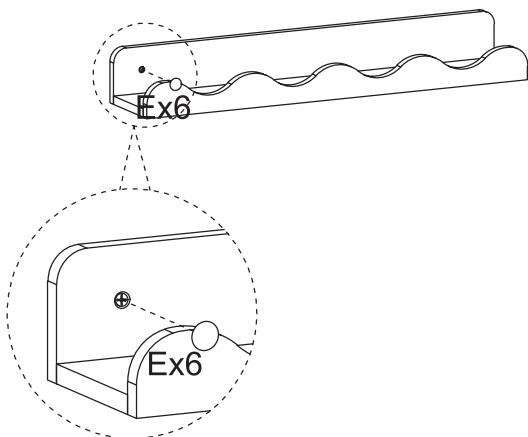

Use 'G' the for
 Plasterboard and 'F'
 for Masonry

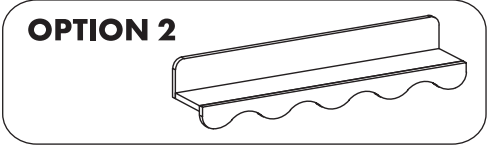

STEP 1

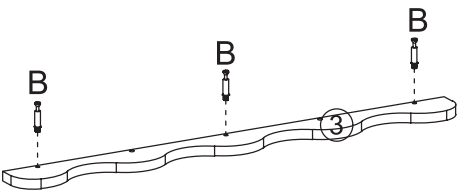

STEP 2

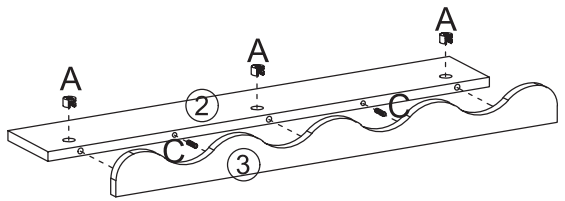

STEP 3

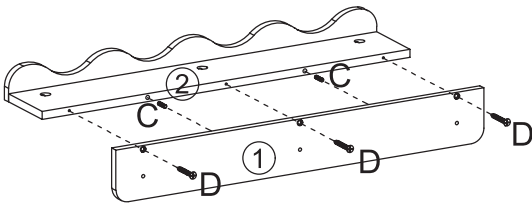

STEP 4

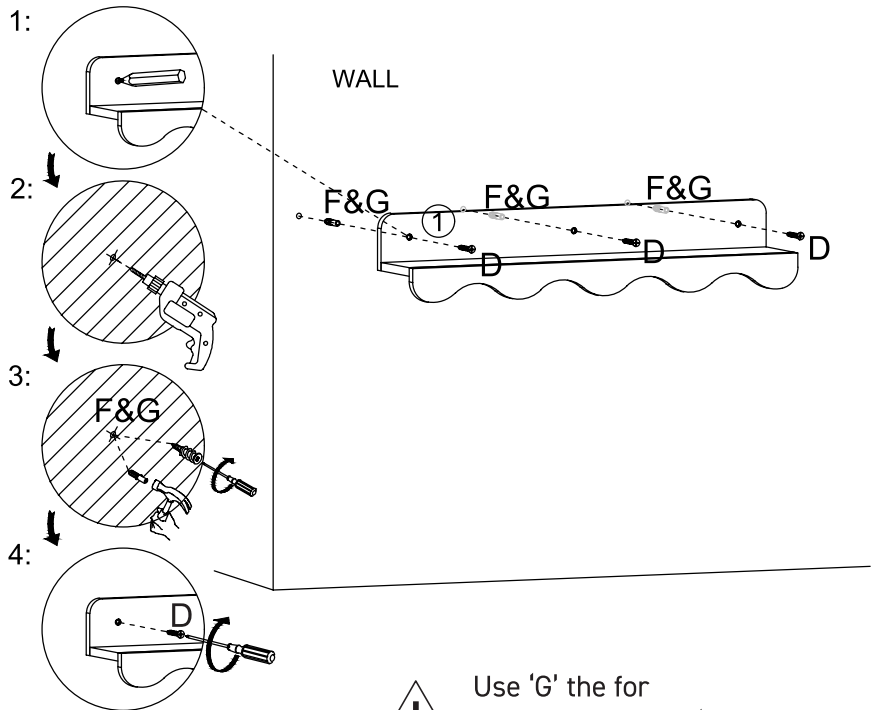

STEP 5

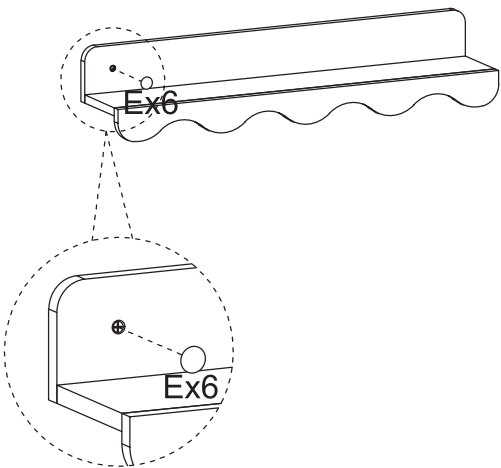

Use 'G' the for
 Plasterboard and 'F'
 for Masonry

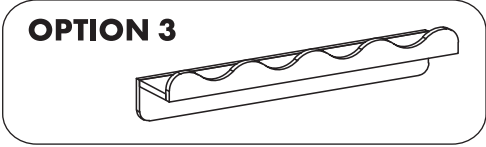

STEP 1

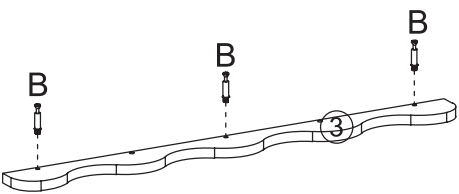

STEP 2

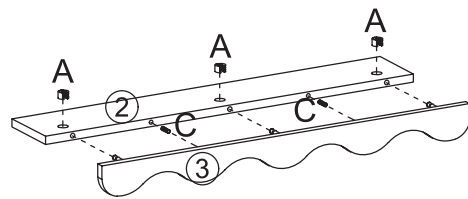

STEP 3

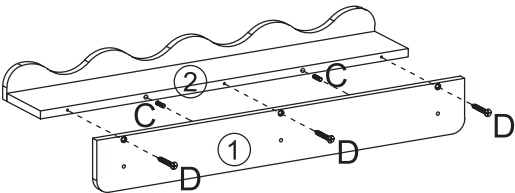

STEP 4

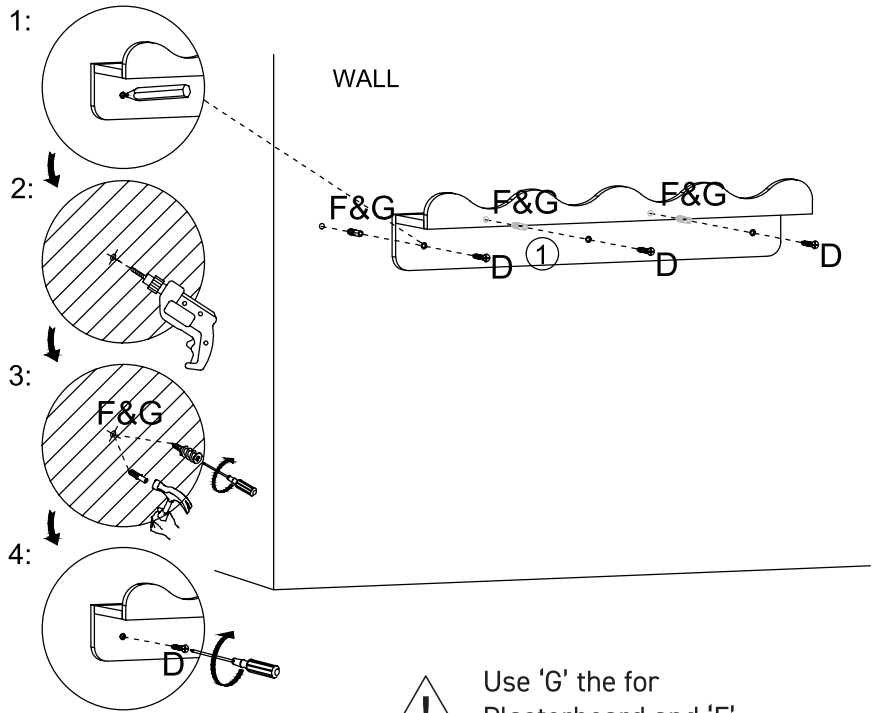

STEP 5

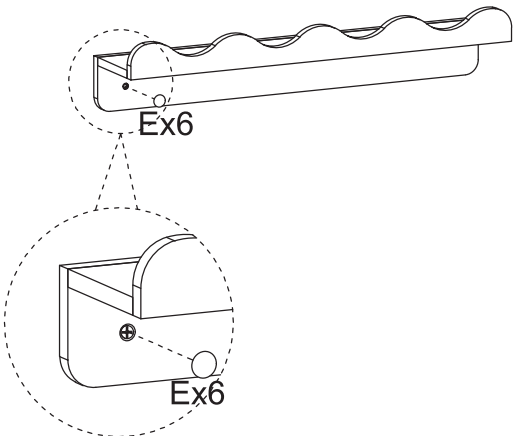

 Use 'G' the for
 Plasterboard and 'F'
 for Masonry

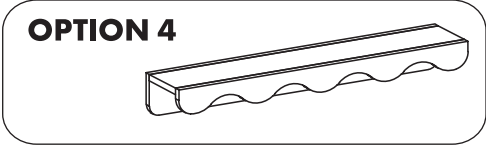

STEP 1

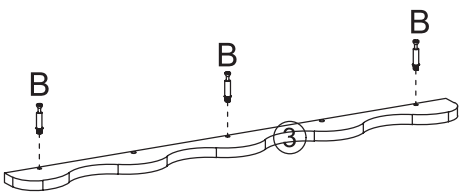

STEP 2

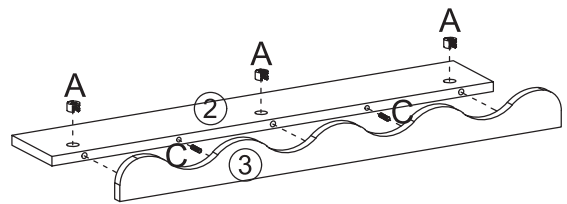

STEP 3

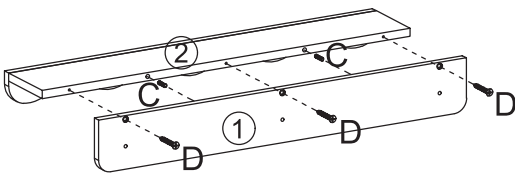

STEP 4

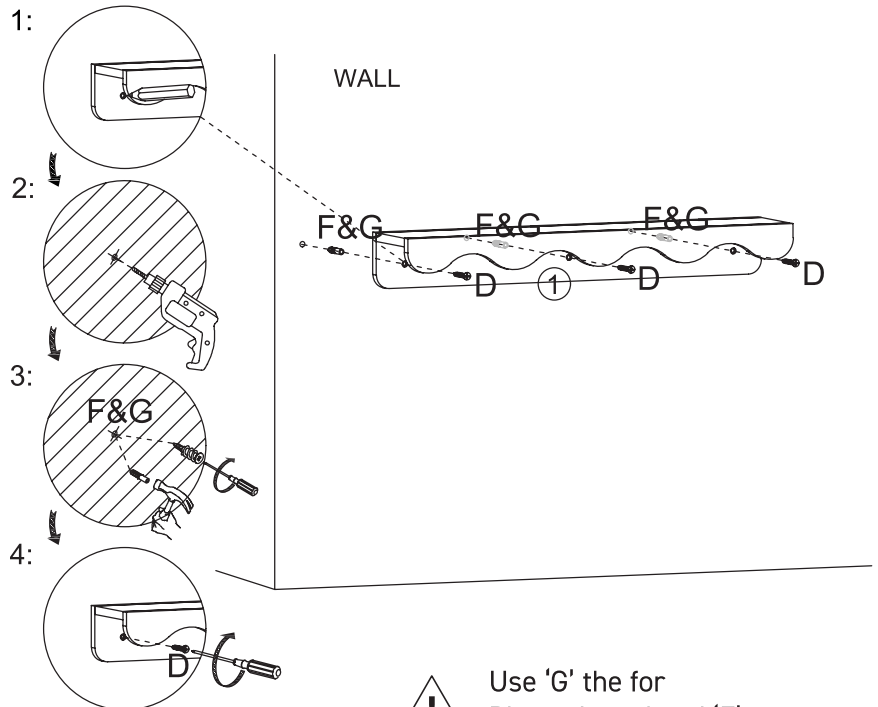

STEP 5

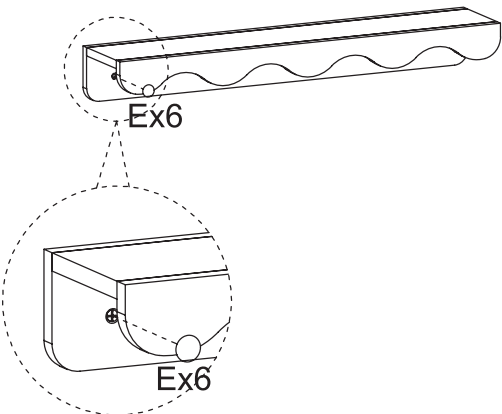

Use 'G' the for Plasterboard and 'F' for Masonry