

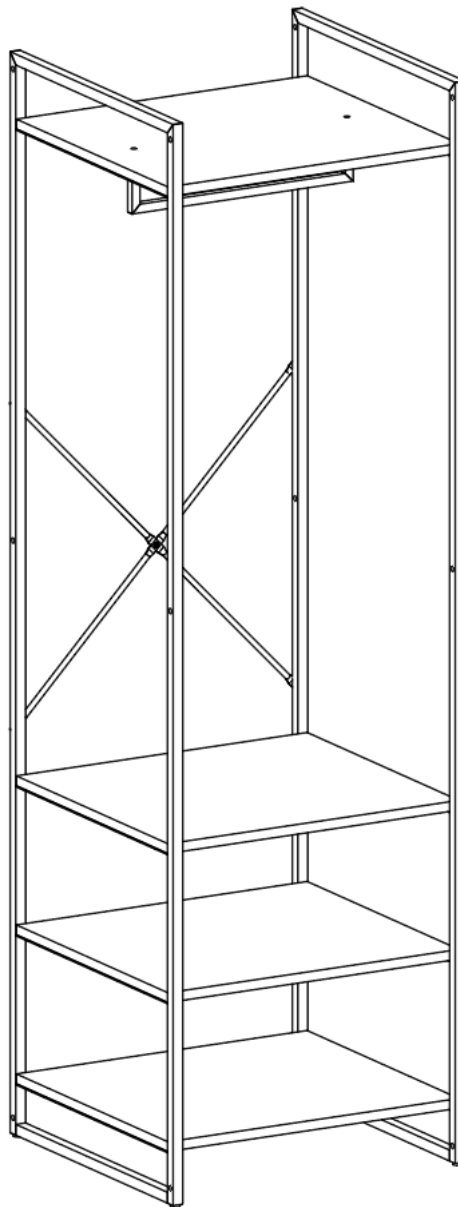

**THIS PRODUCT SHOULD BE PERMANENTLY ANCHORED TO THE WALL OR
OTHER SUITABLE SURFACE TO AVOID SERIOUS INJURY OR DEATH.**

To help avoid any serious injury or death, this product includes a bracket to prevent toppling. We strongly recommend that this product be permanently fixed to the wall or other suitable surface. Fixing hardware is not included since different surface materials require different attachments. Please seek professional advice if you are in doubt what fixing hardware to use. Regularly check your fixing device.







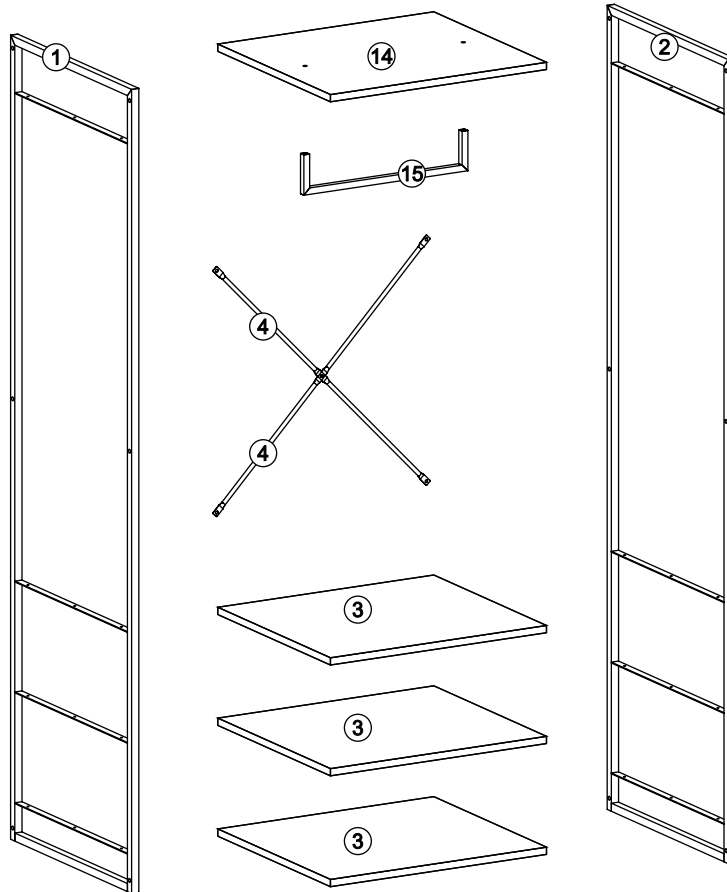



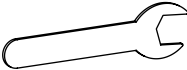

Care Instructions: We recommend to wipe over with a dry micro-fibre cloth to remove dust. Avoid using a damp or wet cloth and any cleaning chemicals as this may cause damage to the surface.

ELEMENTS

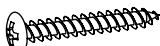

HARDWARE

<p>A</p>  <p>x25</p>	<p>B</p>  <p>x5</p>	<p>C</p>  <p>x1</p>	<p>D</p>  <p>x1</p>	<p>E</p>  <p>x1</p>	<p>F</p>  <p>x4</p>
<p>G</p>  <p>x8</p>	<p>H</p>  <p>x6</p>	<p>I</p>  <p>x1</p>	<p>J</p>  <p>x1</p>	<p>K</p>  <p>x1</p>	<p>L</p>  <p>x1</p>

STEP 1

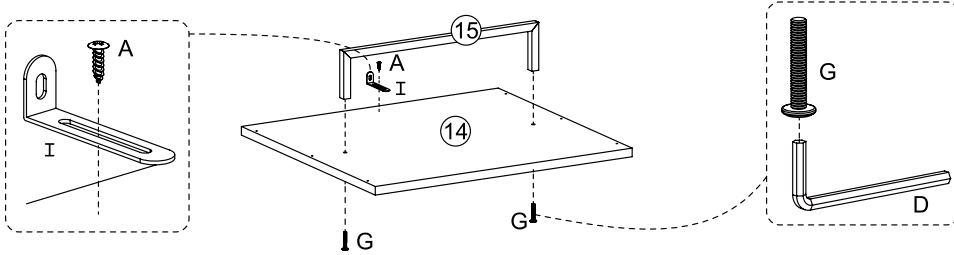

STEP 2

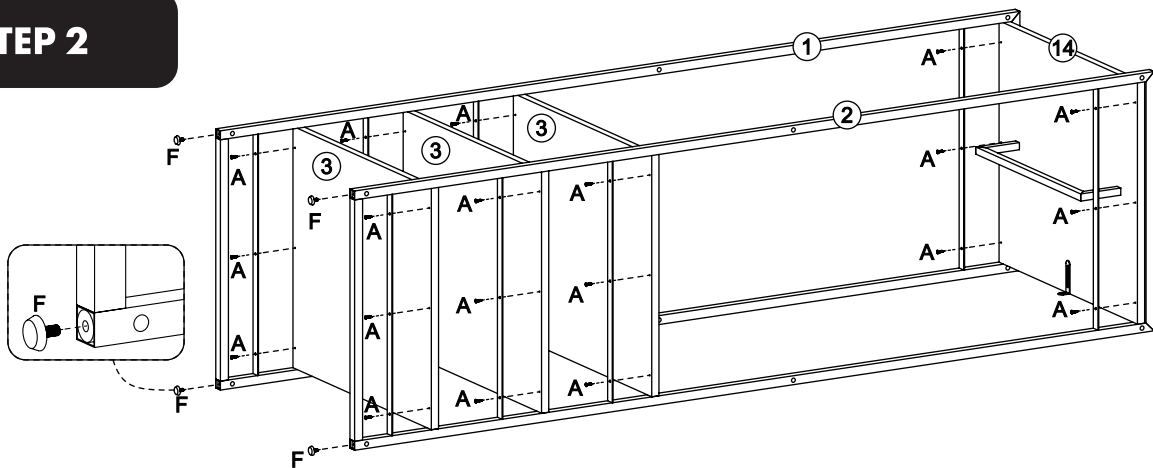

STEP 3

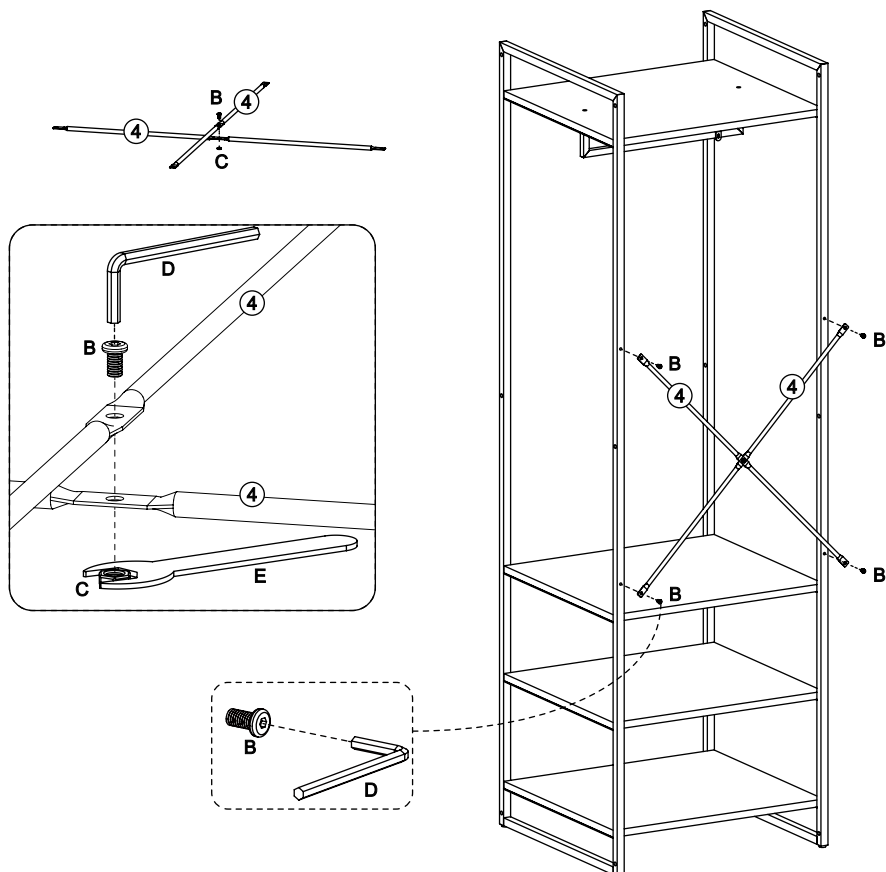

STEP 4

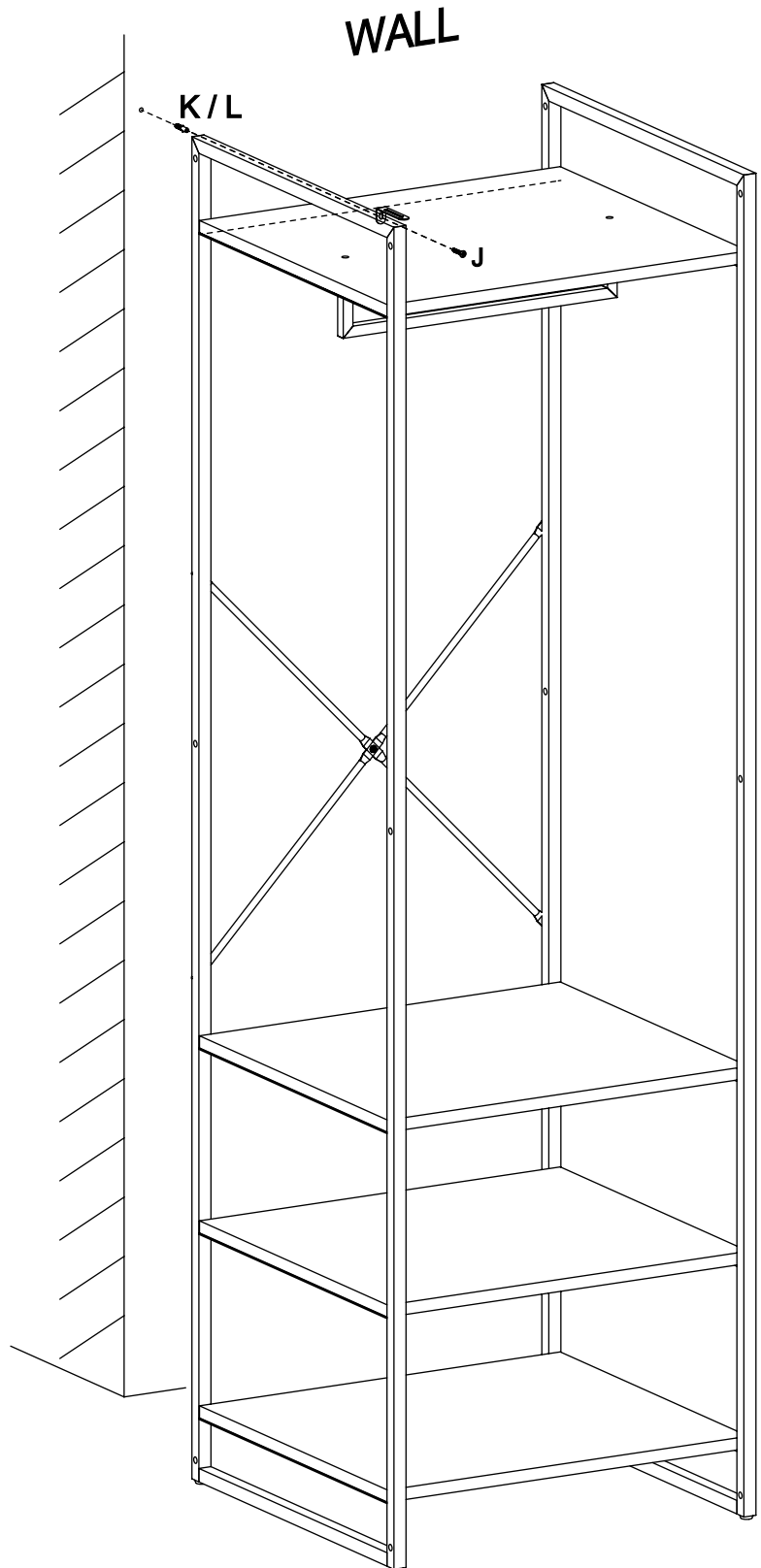
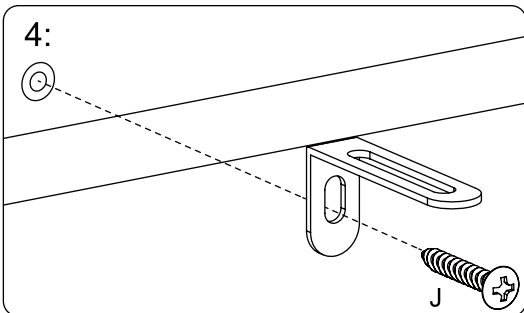
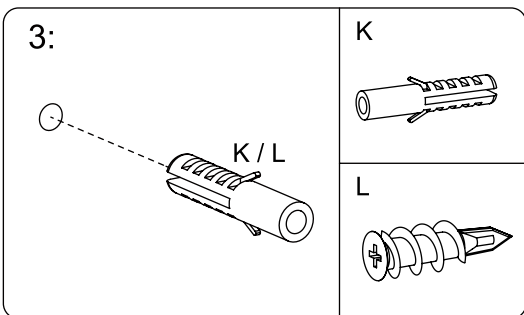
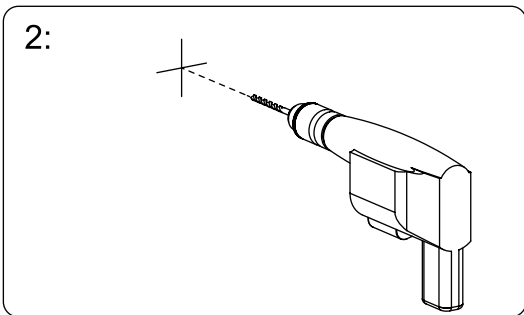
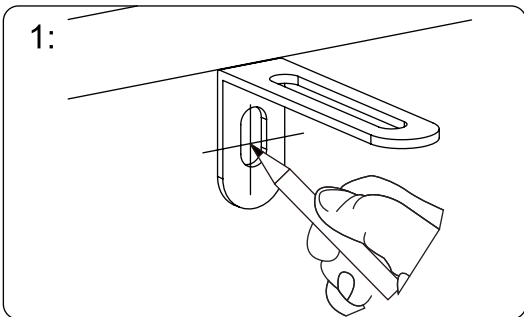

STEP 5

If you have purchased other units in the Flexi Storage Studio range, please follow step 5 for further instructions on how to join your units together.

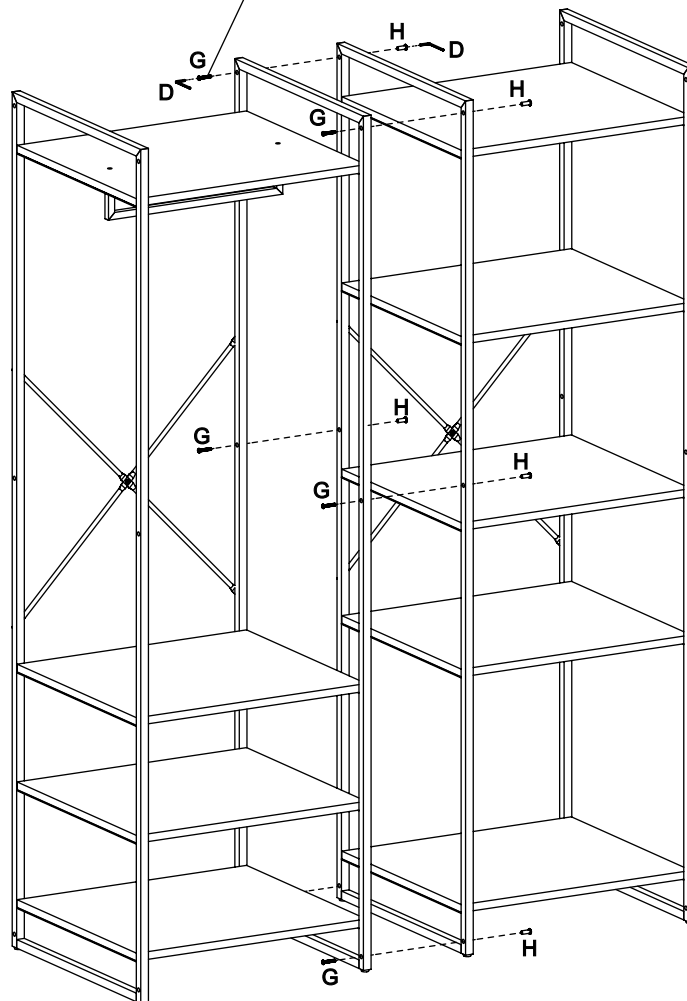
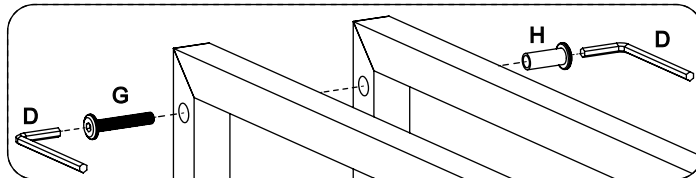
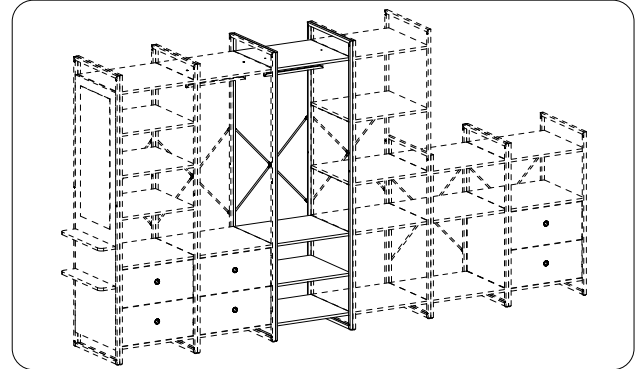

MADE IN CHINA
Distributed by:
Zenexus (AUS) Ph: 1300 734 714
Zenexus (NZ) Ph: 0800 443 058

flexistorage.com.au
flexistorage.co.nz